

1 Térreo - Projeto Arquitetônico - Existente
1 : 50

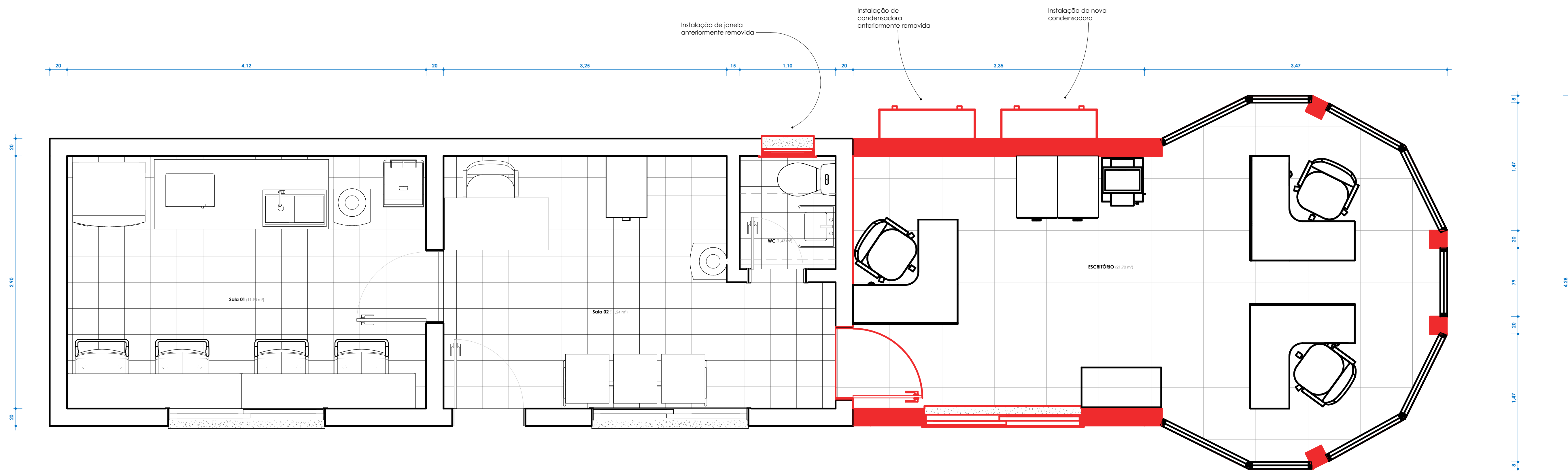

2 Térreo - Projeto Arquitetônico - A Construir
1 : 25

CONSTRUIR
 DEMOLIR



DEPARTAMENTO DE ÁGUA
E ESGOTOS DE BAGE

PROJETO:	Sala Diretoria Operacional		
ASSUNTO:	Projeto Executivo - Existente/Construir		
LOCAL:	Rua Marechal Deodoro, 451 - Sede Administrativa do DAEB	ESCALA:	INDICADA
RESPONSÁVEL TÉCNICO:	Eng. João Vitor Garcia Mansur - CREA-RS 264302	DATA:	23/03/2026
DIRETOR GERAL:	Max Geraldo Meinke	PRACHA:	01 /04

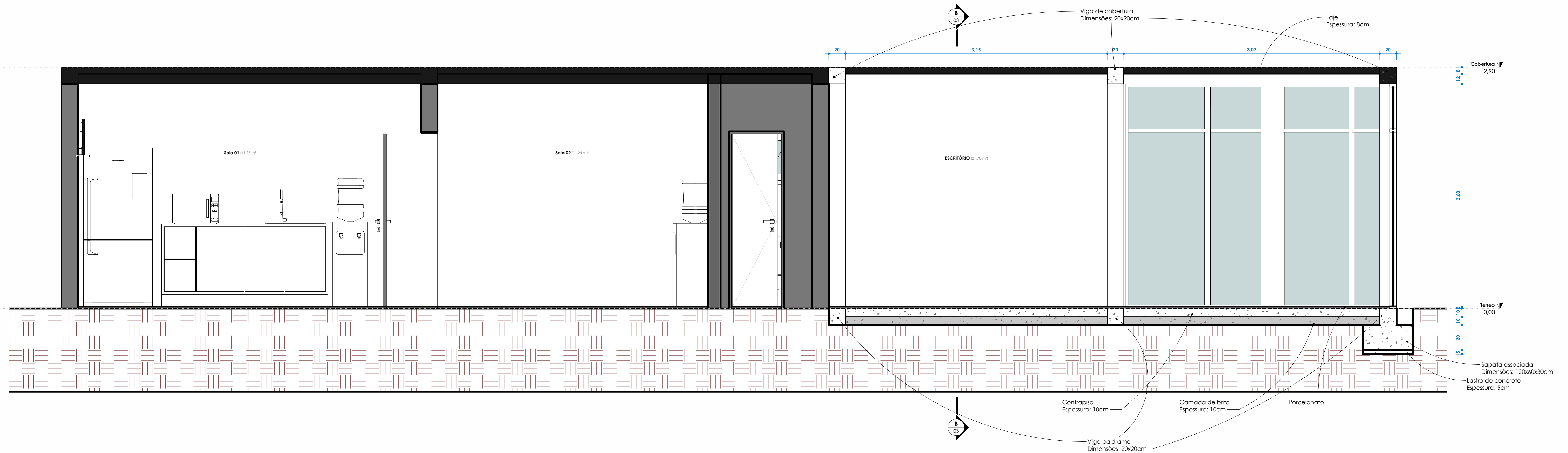

1 A
1 : 25

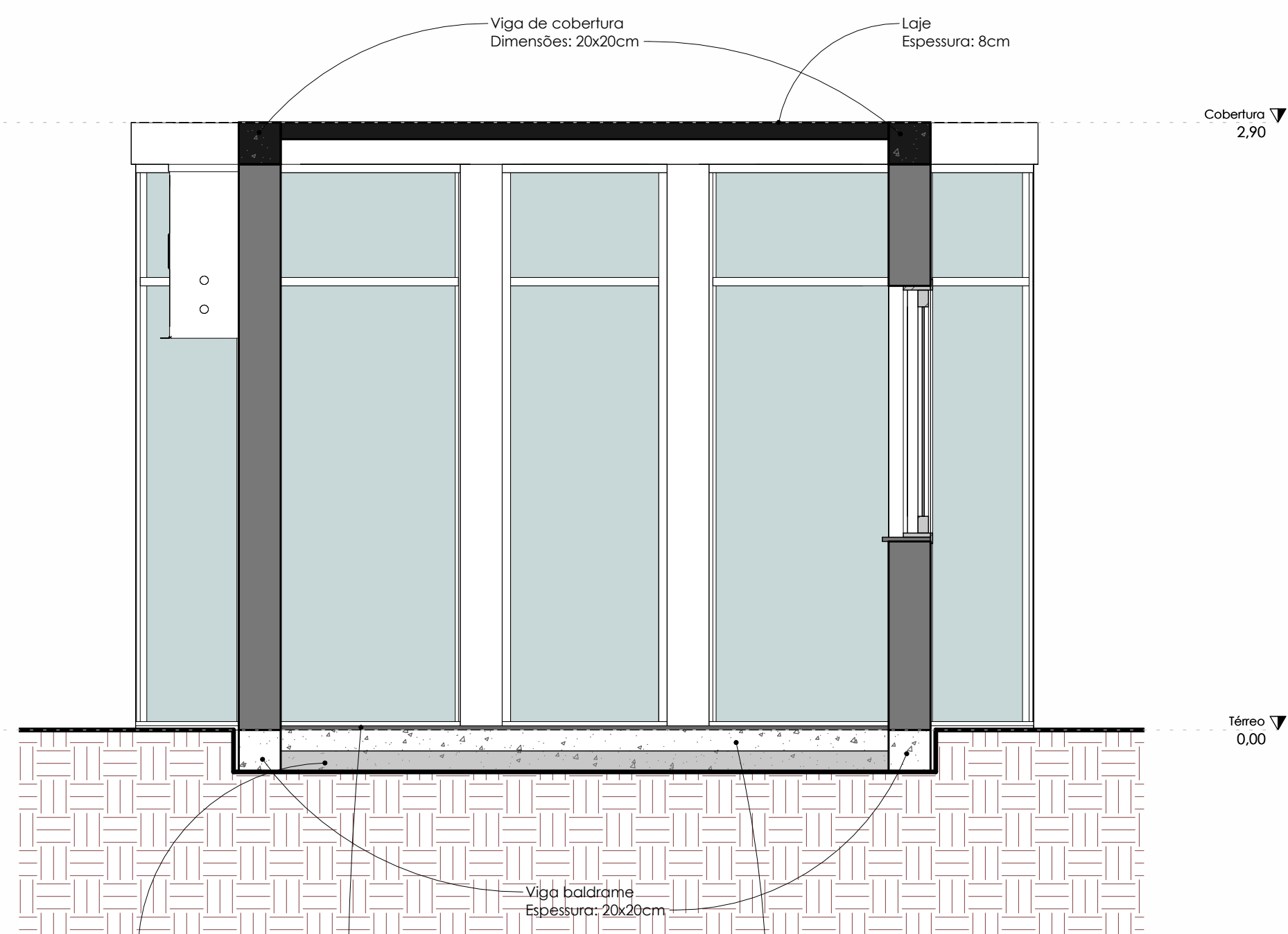

2 B
1 : 25

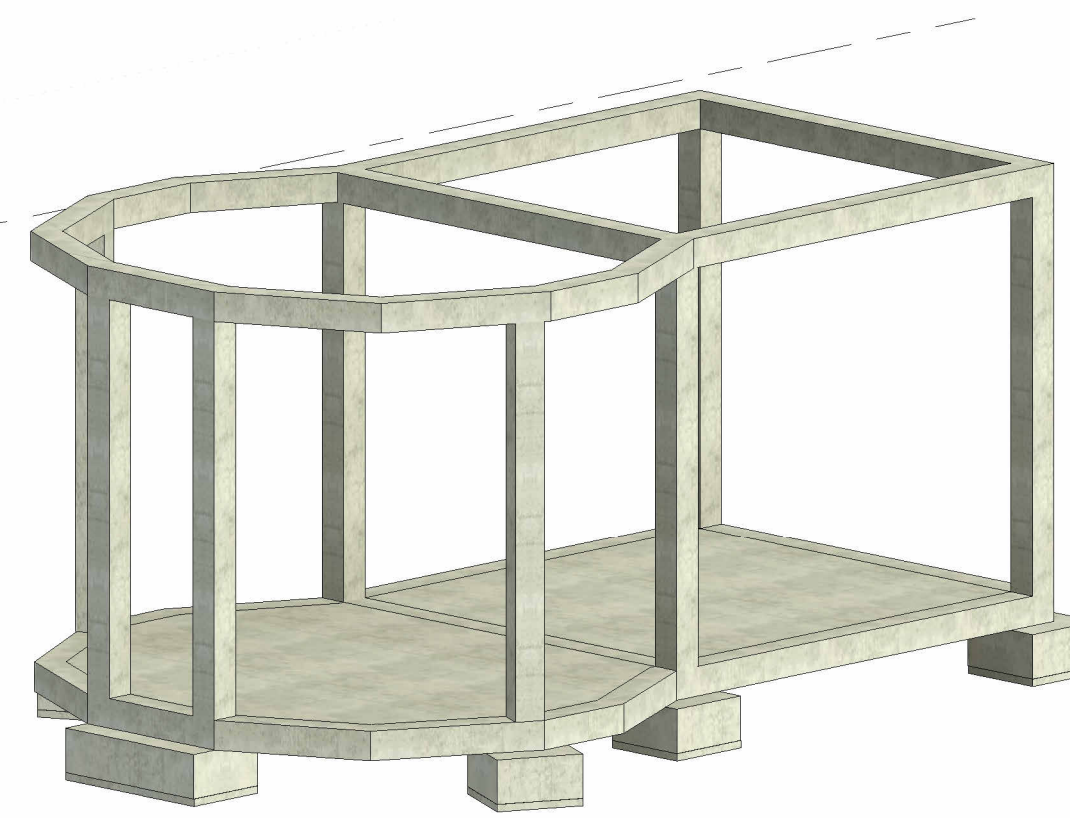

3 Vista 3D - 03

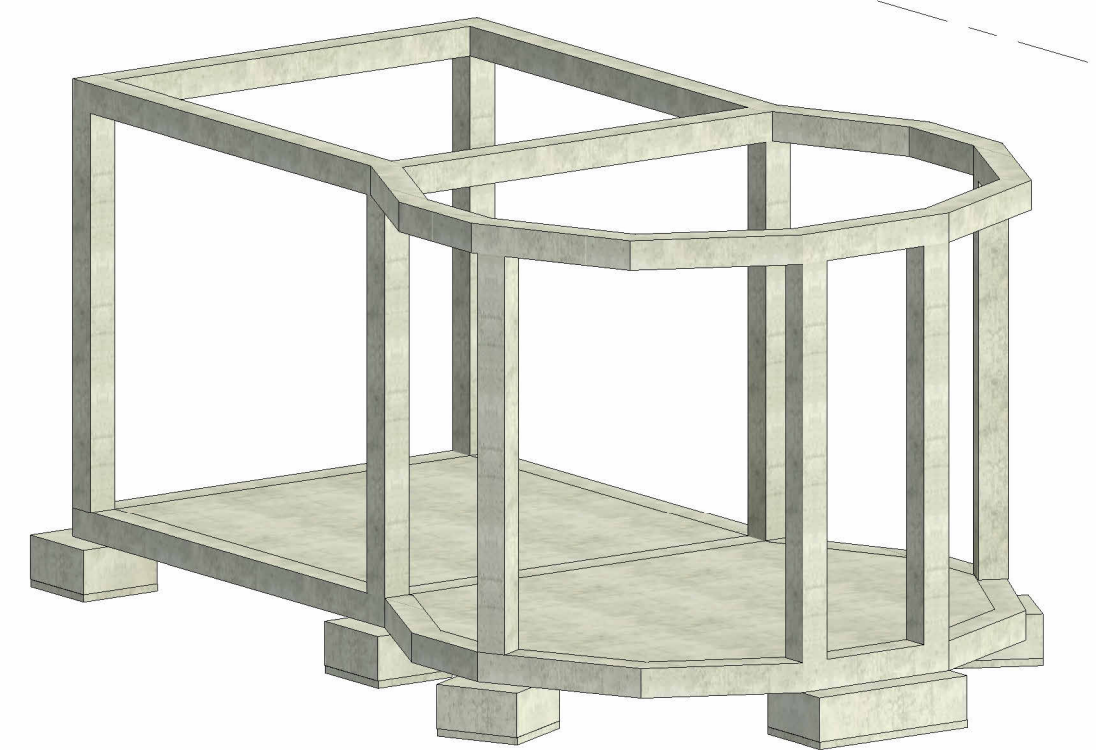

4 Vista 3D - 04



DEPARTAMENTO DE ÁGUA E ESGOTOS DE BÁGE

PROJETO: Sala Diretoria Operacional

ASSUNTO: Projeto Arquitetônico

LOCAL: Rua Marechal Deodoro, 451 - Sede Administrativa do DAEB

ESCALA: INDICADA

RESPONSÁVEL TÉCNICO: Eng. João Vitor Garcia Mansur - CREA-RS 264302
DATA: 23/03/2026

DIRETOR GERAL: Max Geraldo Meinke

PRACHA: 03 / 04

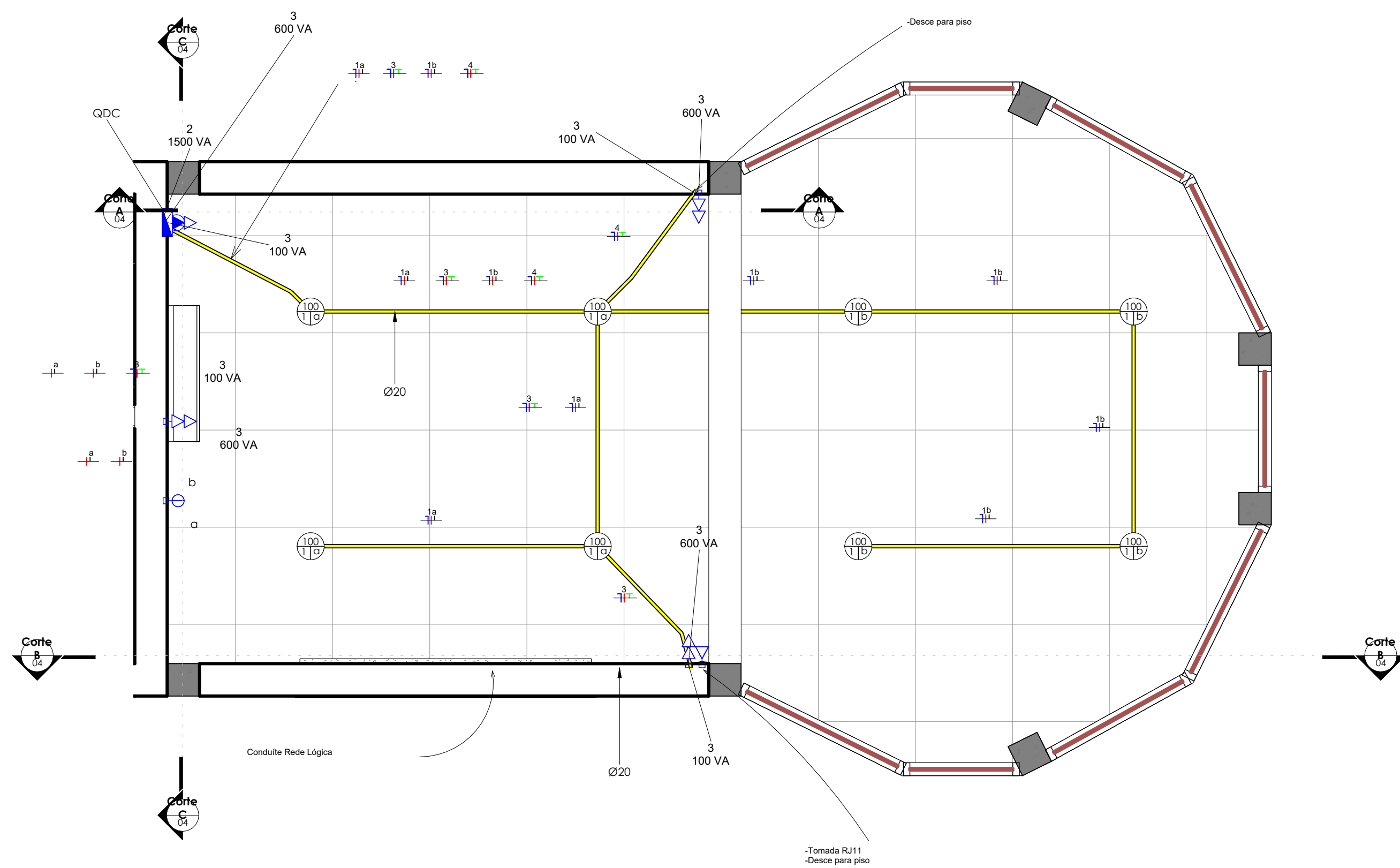

1 Térreo - Projeto Elétrico - Laje

1 : 25

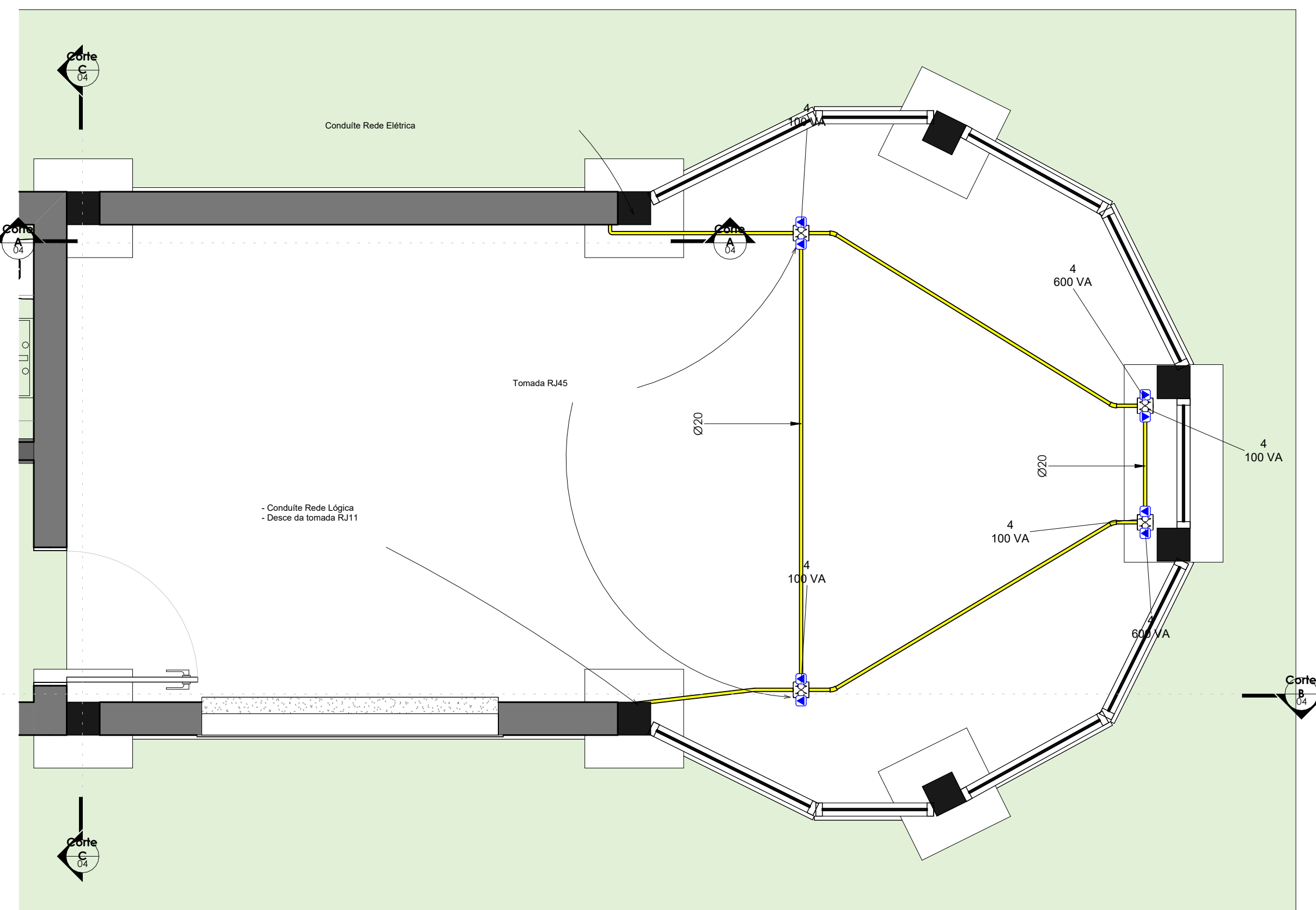

3 Térreo - Projeto Elétrico - Piso

1 : 25

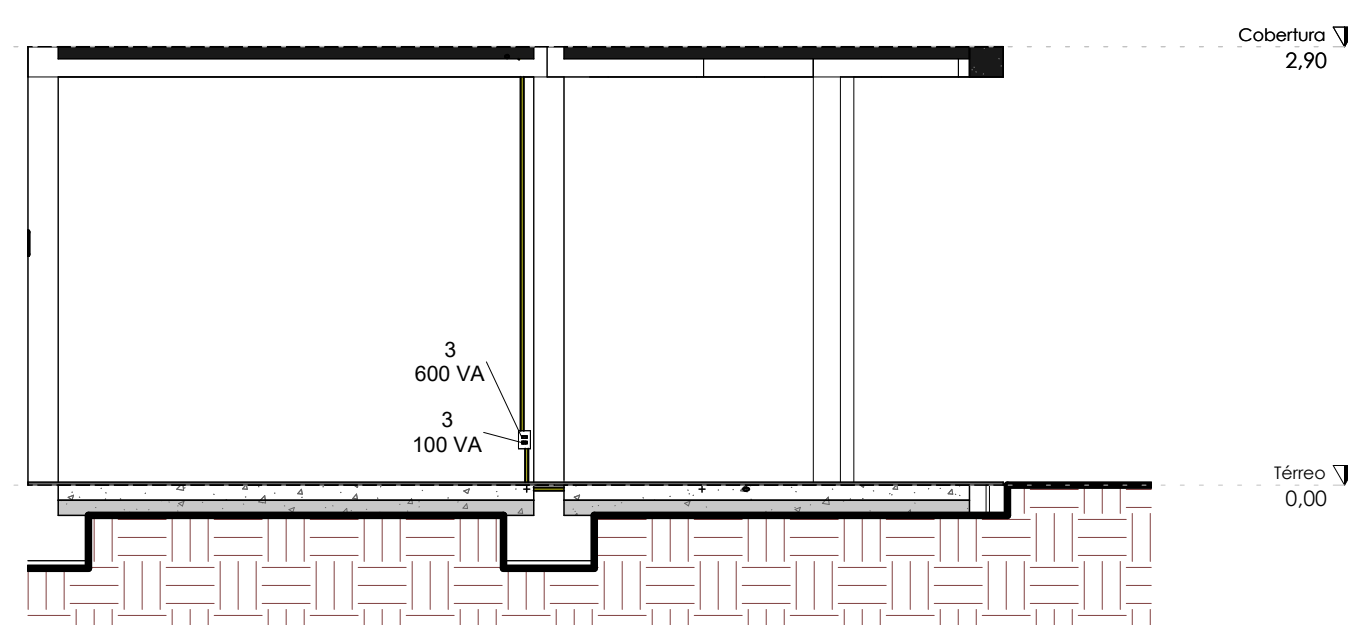

4 Corte A

1 : 50

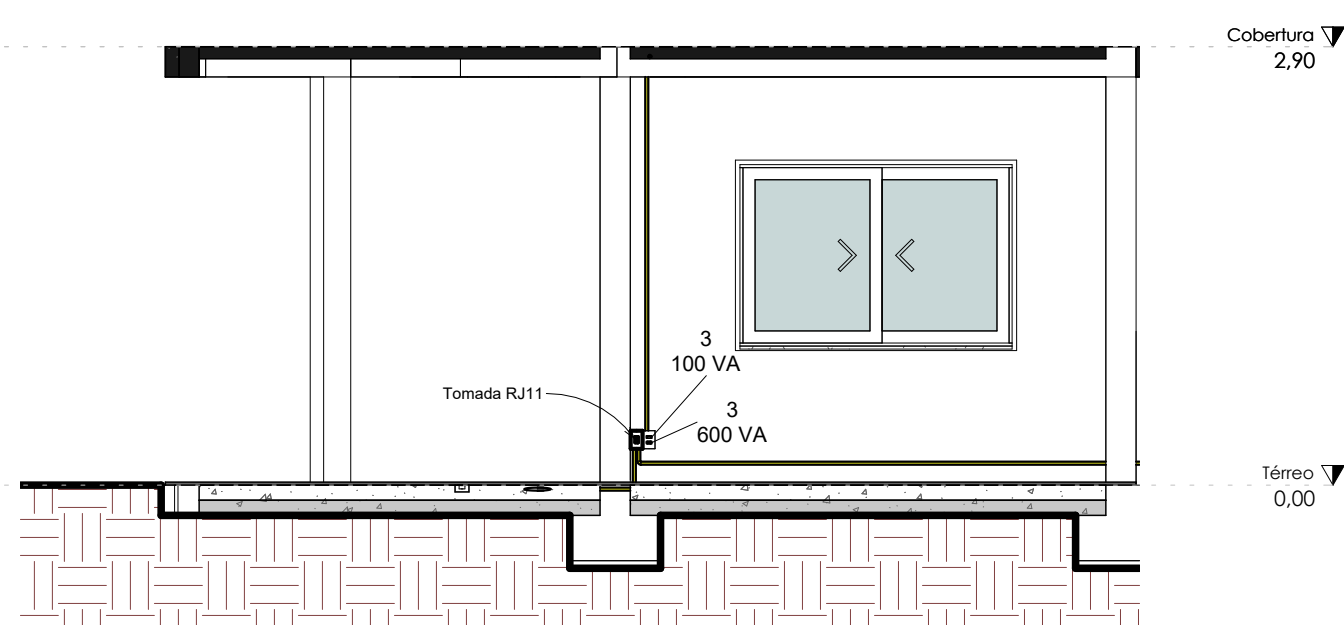

5 Corte B

1 : 50

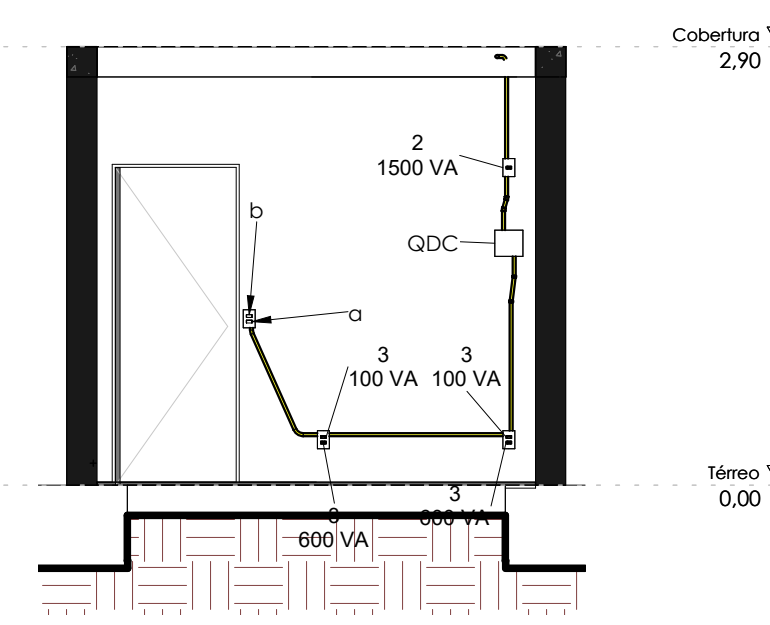

6 Corte C

1 : 50

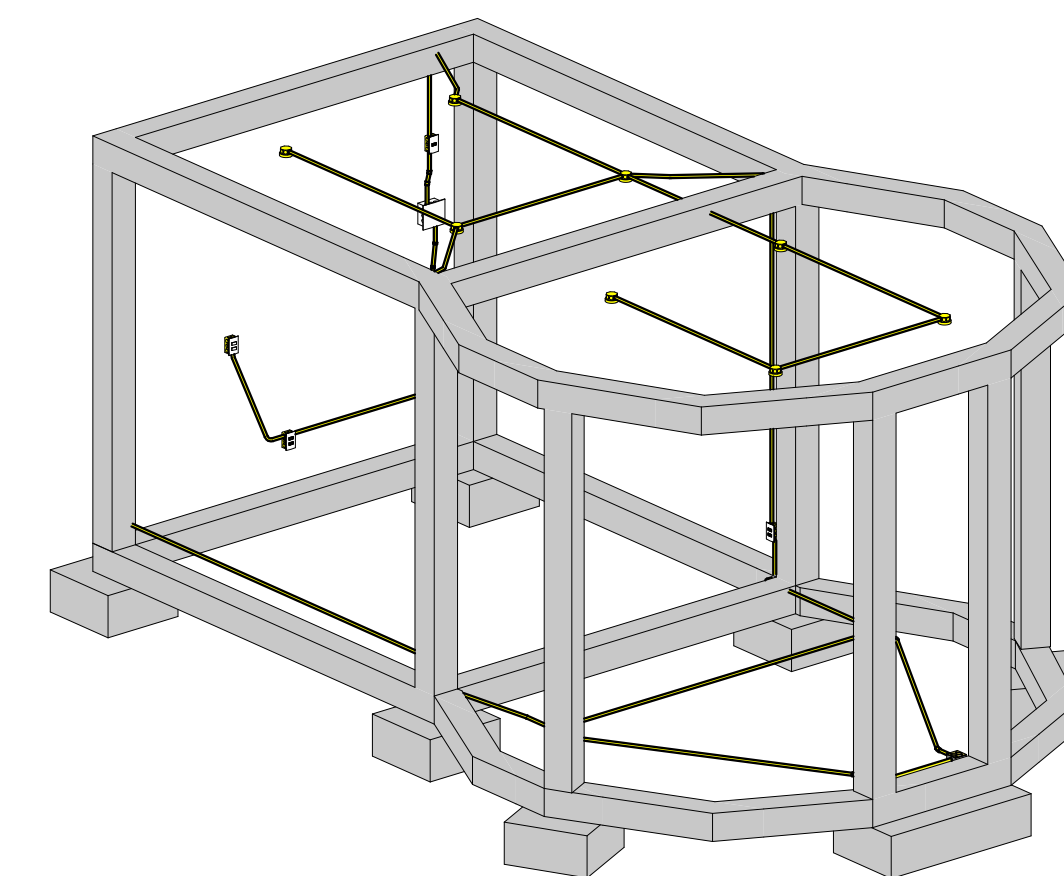

2 Vista 3D Elétrico



DEPARTAMENTO DE ÁGUA
E ESGOTOS DE BÁGE

PROJETO: Sala Diretoria Operacional

ASSUNTO: Projeto Elétrico

LOCAL: Rua Marechal Deodoro, 451 - Sede Administrativa do DAEB

ESCALA: INDICADA

RESPONSÁVEL TÉCNICO

DATA: 23/03/2026

Eng. João Vitor Garcia Mansur - CREA-RS 264302

DIRETOR GERAL: Max Geraldo Meinke

FRACIA: 04 / 04