

Prefeitura Municipal de Ivorá

ALvenaria – Unidades Habitacionais – 55,70 m²

Vitor Camargo Costa
CREARS 203284

Data: 03/2026



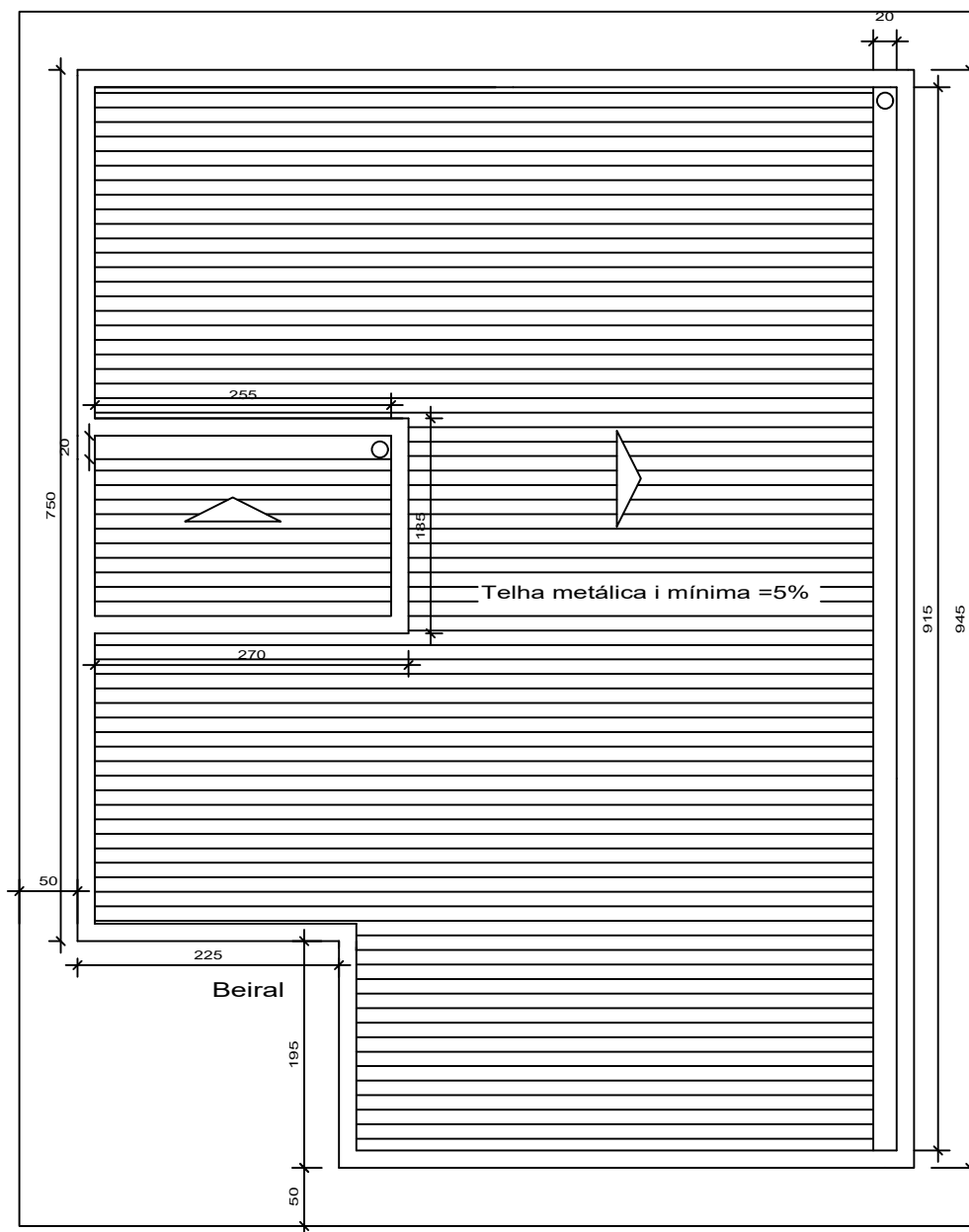

Prefeitura Municipal de Ivorá

Cobertura – Unidades Habitacionais – 55,70 m²

Vitor Camargo Costa
CREARS 203284

Data: 03/2026



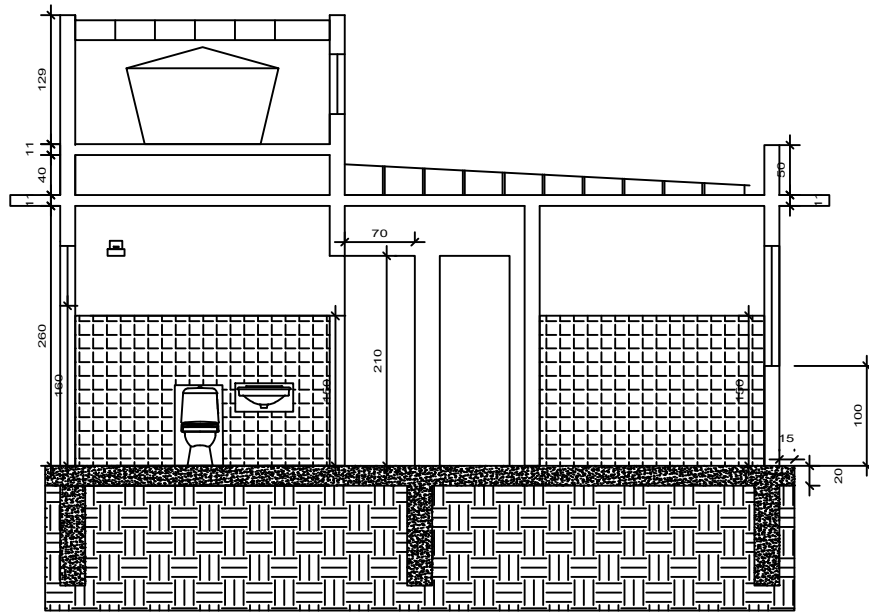

CORTE AA

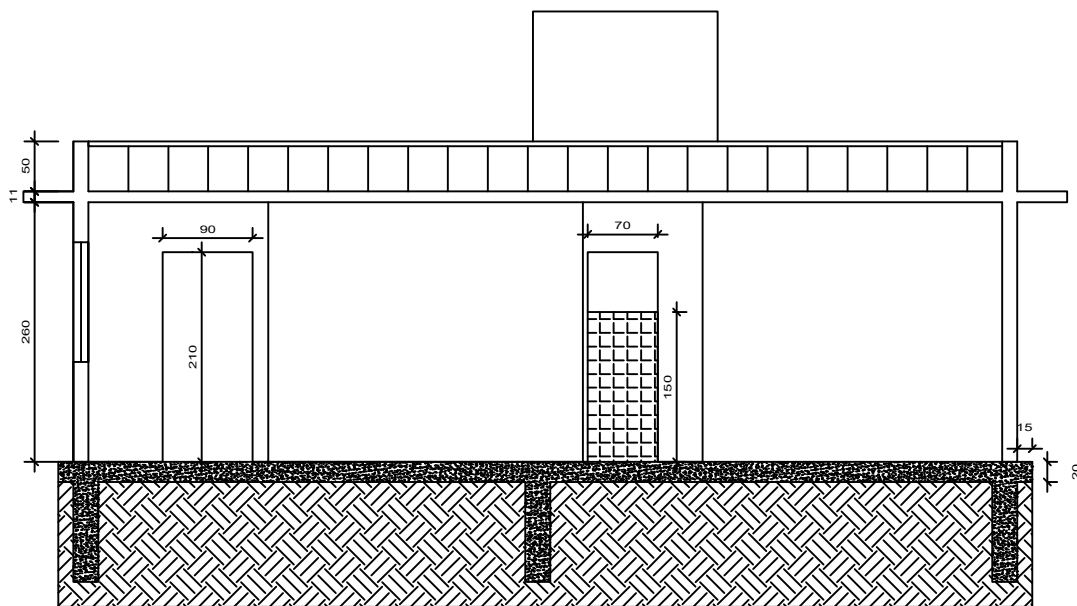

CORTE BB

Prefeitura Municipal de Ivorá

CORTES AA E BB – Unidades Habitacionais – 55,70 m²

Vitor Camargo Costa
CREARS 203284

Data: 03/2026



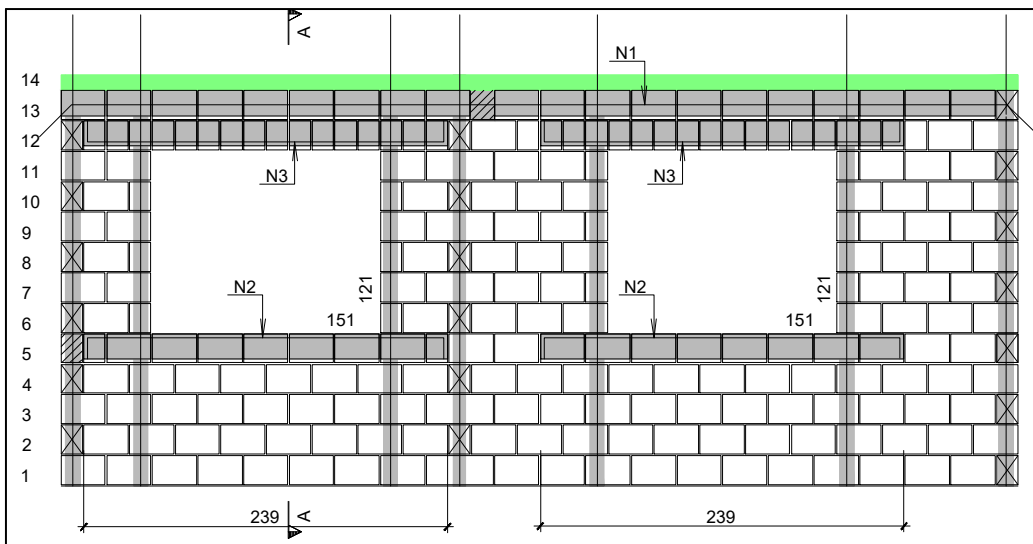

Corte A-A

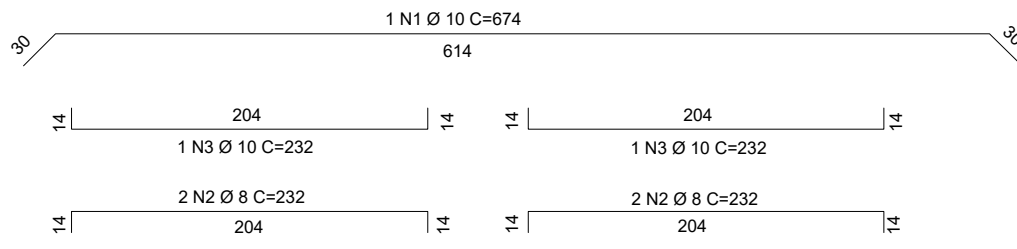
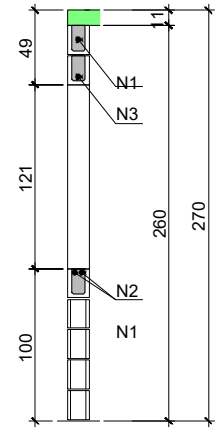

Corte A-A

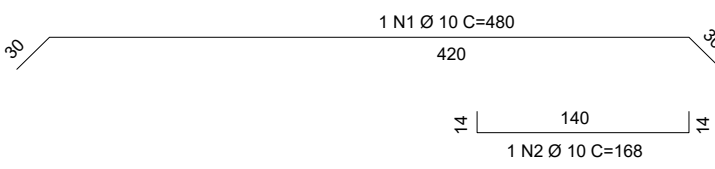
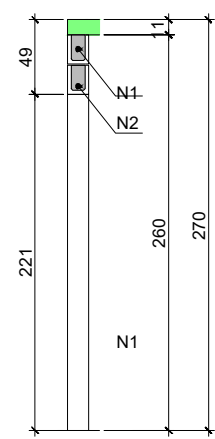
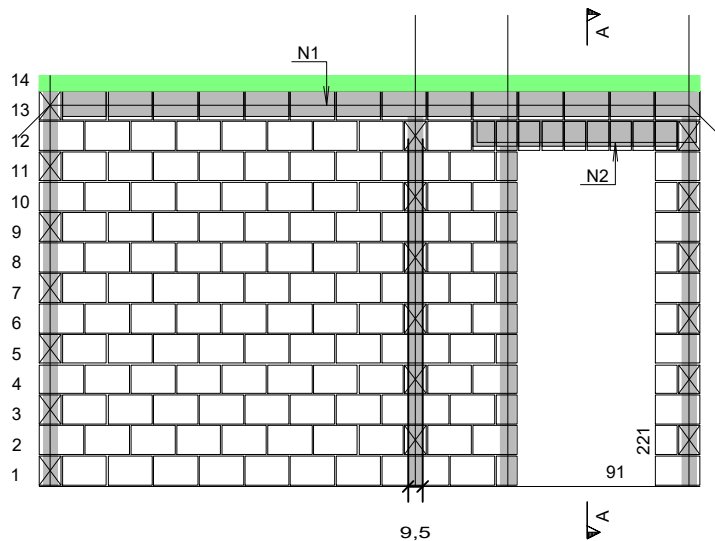

Prefeitura Municipal de Ivorá

Detalhe Alvenaria – Unidades Habitacionais – 55,70 m²

Vitor Camargo Costa
CREARS 203284

Data: 03/2026



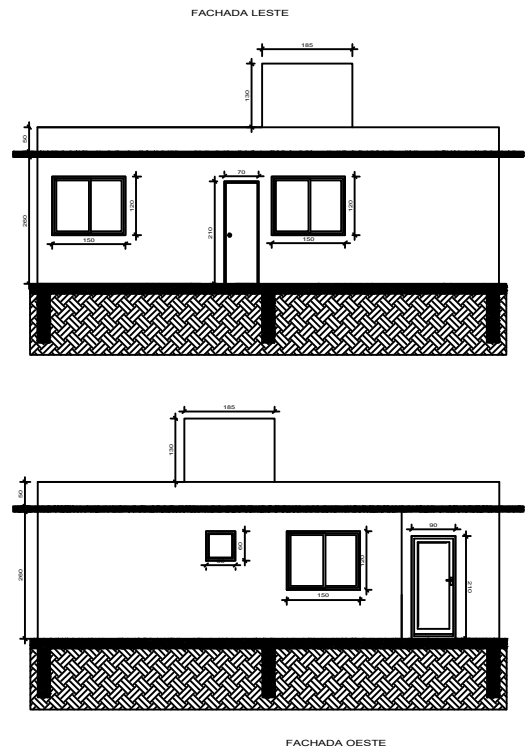
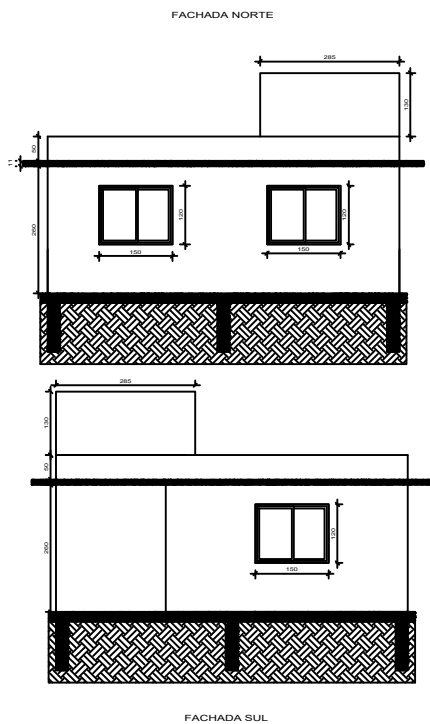

Prefeitura Municipal de Ivorá

FACHADAS – Unidades Habitacionais – 55,70 m²

Vitor Camargo Costa
CREARS 203284

Data:



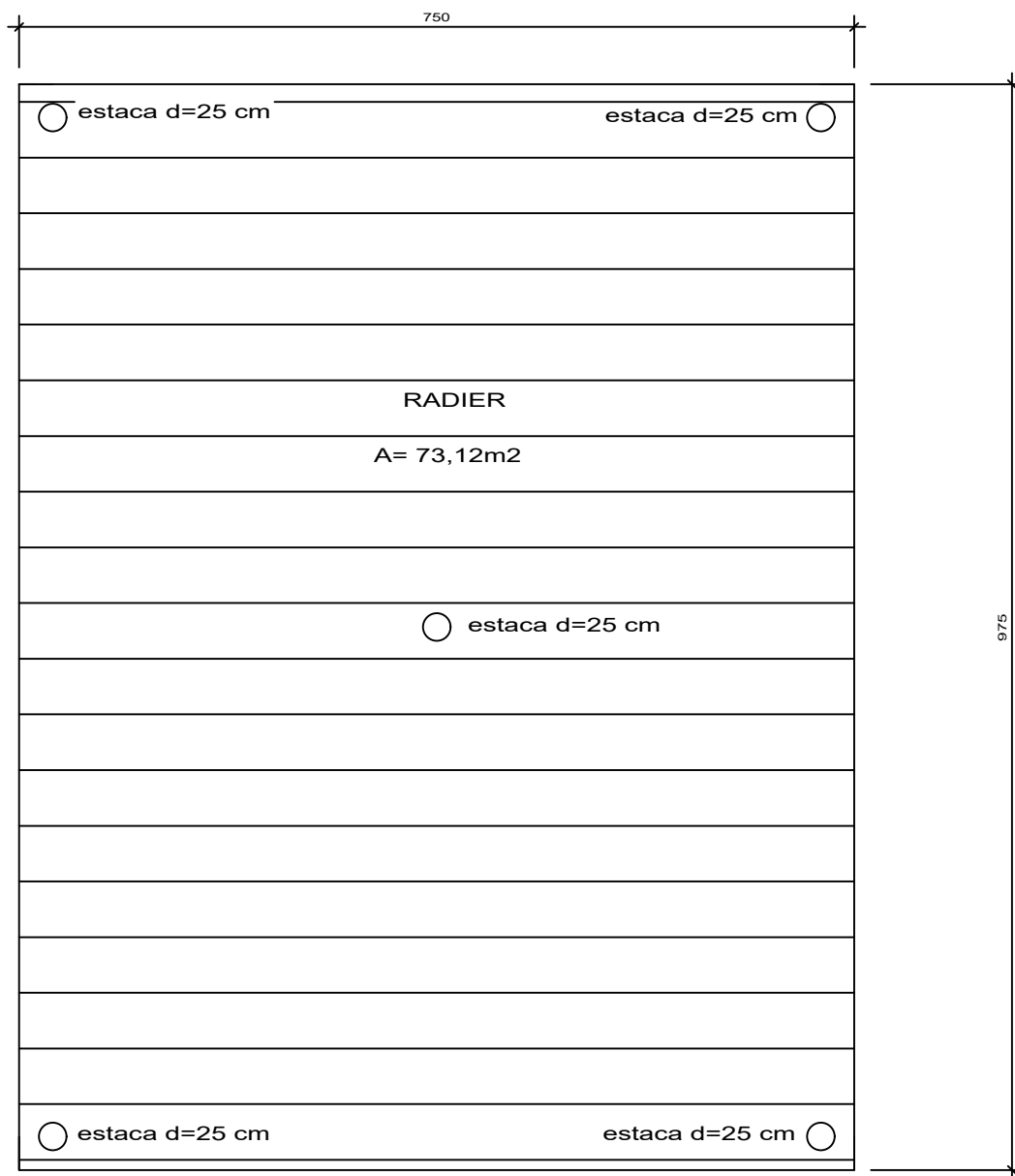

Prefeitura Municipal de Ivorá

Radier – Unidades Habitacionais – 55,70 m²

Vitor Camargo Costa
CREARS 203284

Data: 03/2026



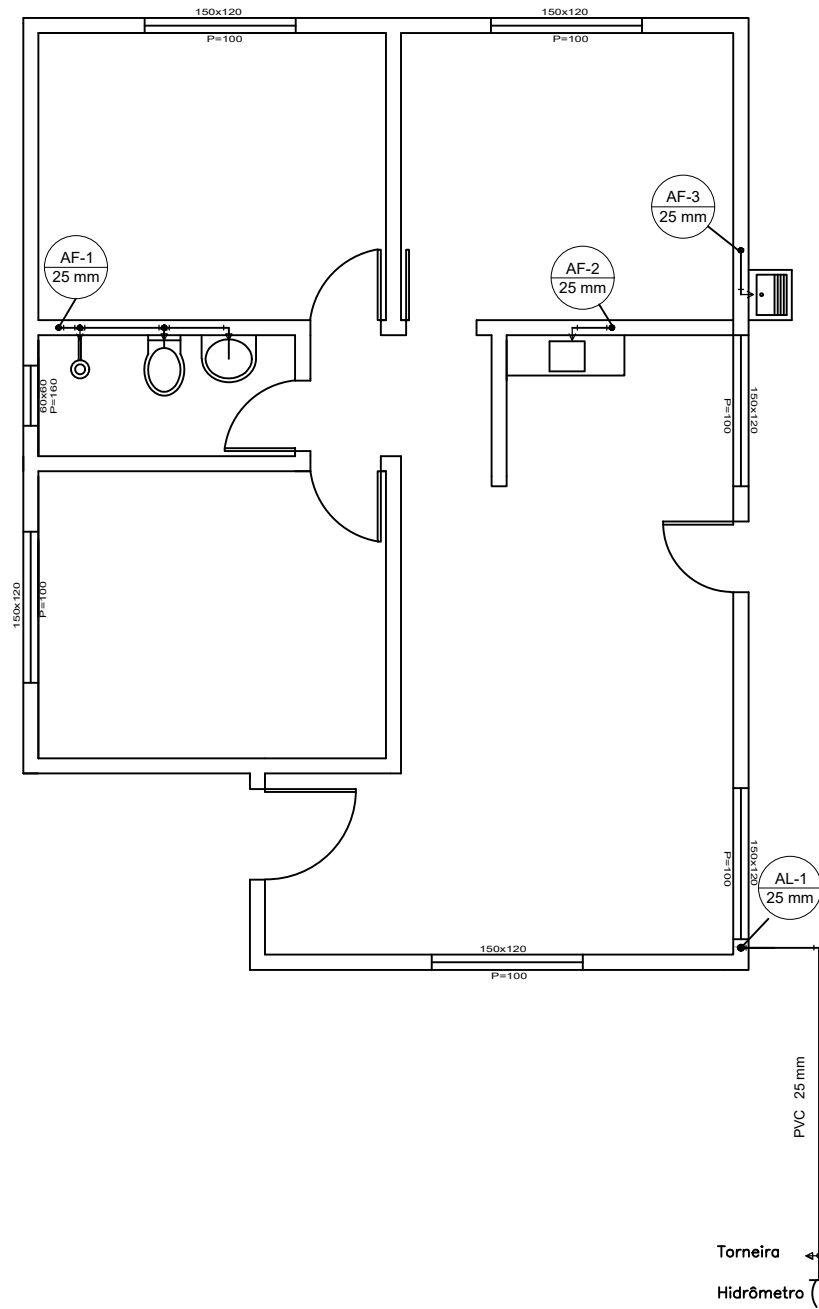

Prefeitura Municipal de Ivorá

Instalações hidráulicas 1 – Unidades Habitacionais – 55,70 m²

Vitor Camargo Costa
CREARS 203284

Data: 03/2026



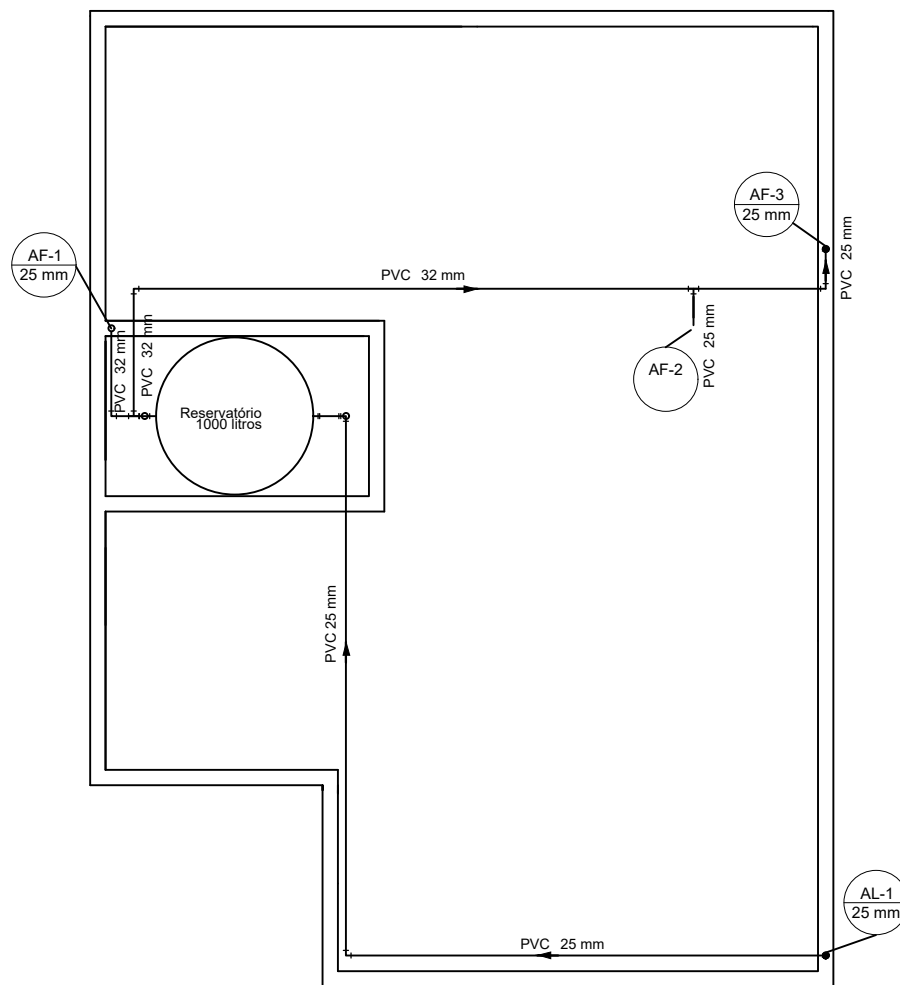

Prefeitura Municipal de Ivorá

Instalações hidráulicas 2 – Unidades Habitacionais – 55,70 m²

Vitor Camargo Costa
CREARS 203284

Data: 03/2026



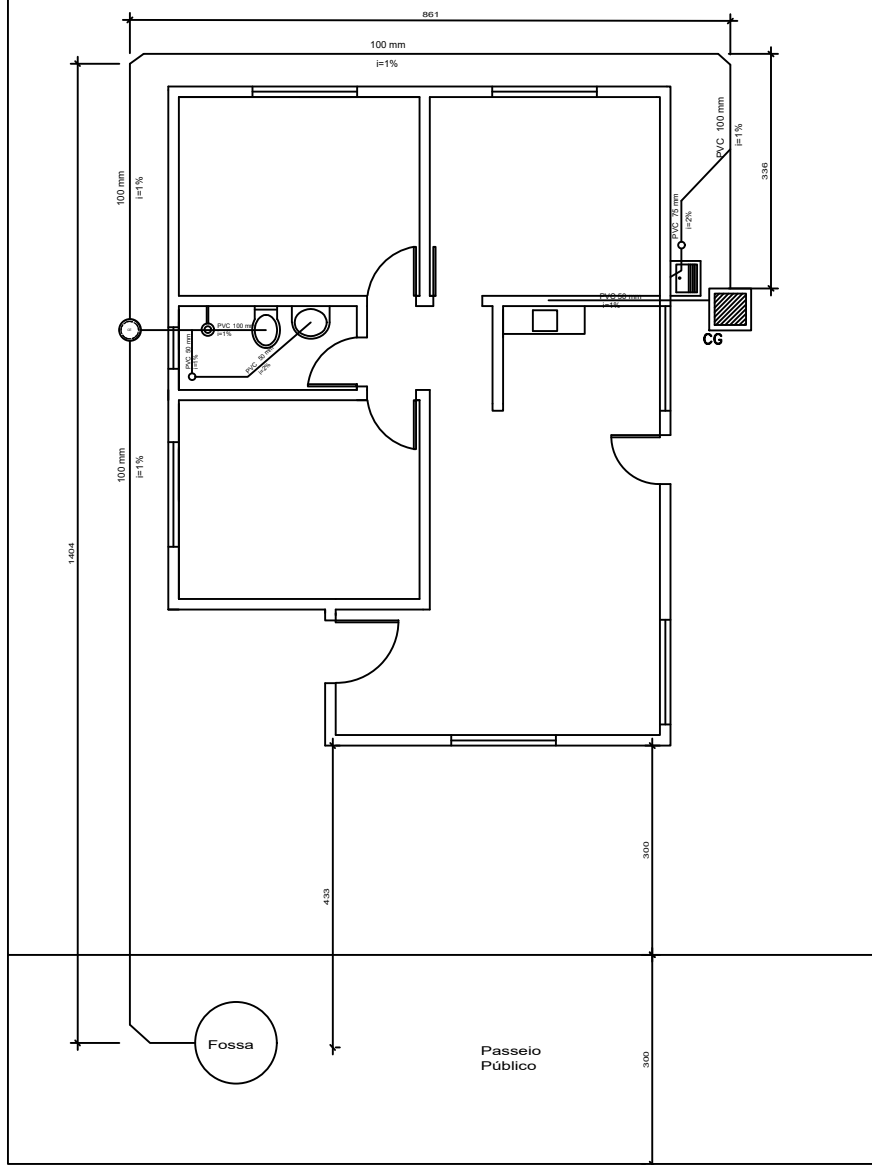

Rua Euclides Londero

Prefeitura Municipal de Ivorá

Hidrossanitário – Unidades Habitacionais – 55,70 m²

Vitor Camargo Costa
CREARS 203284

Data: 03/2026



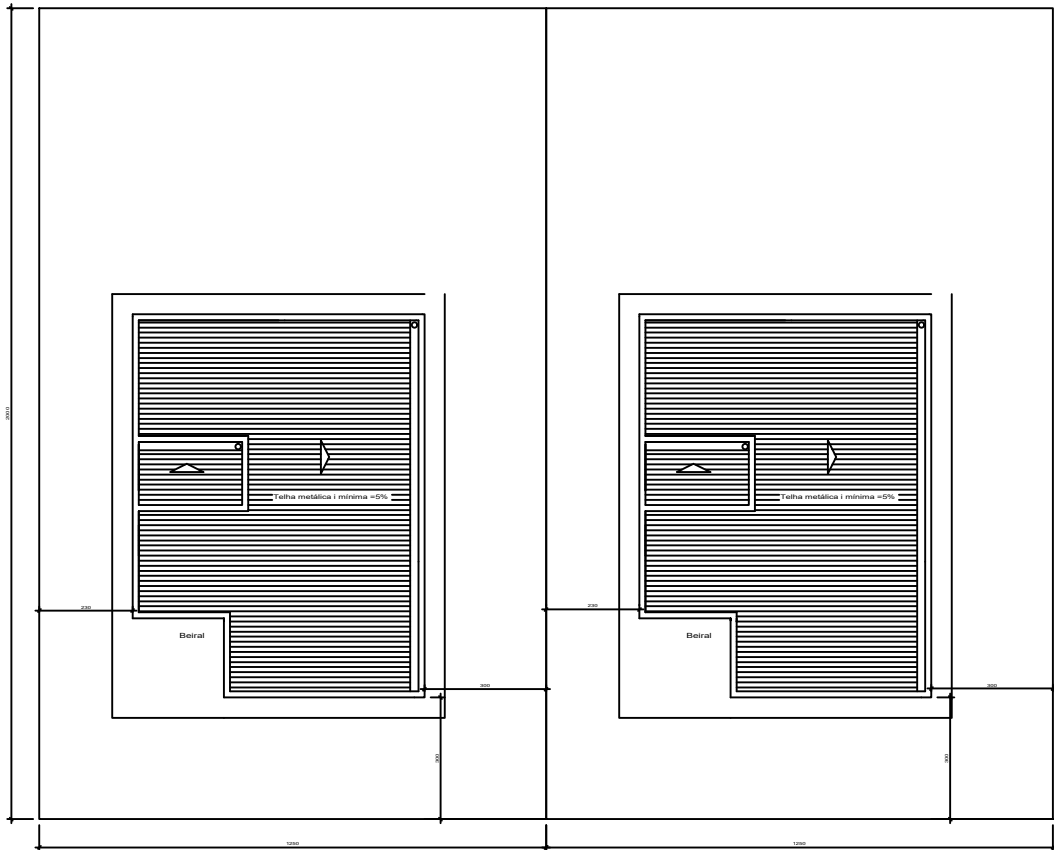

Rua Euclides Londero

Prefeitura Municipal de Ivorá

Locação – Unidades Habitacionais – 55,70 m²

Vitor Camargo Costa
CREARS 203284

Data: 03/2026



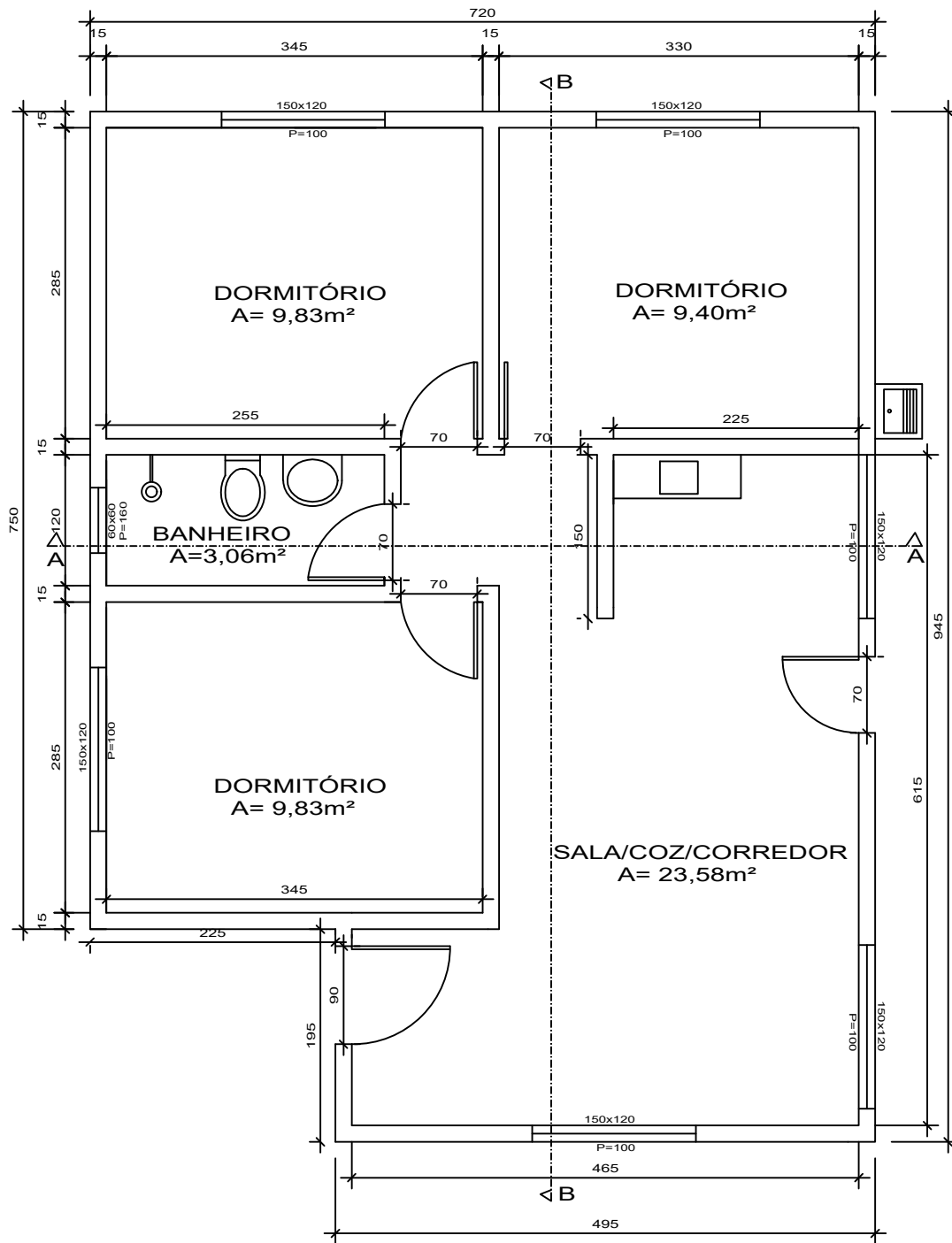

Prefeitura Municipal de Ivorá

Planta Baixa – Unidades Habitacionais – 55,70 m²

Vitor Camargo Costa
CREARS 203284

Data: 03/2026



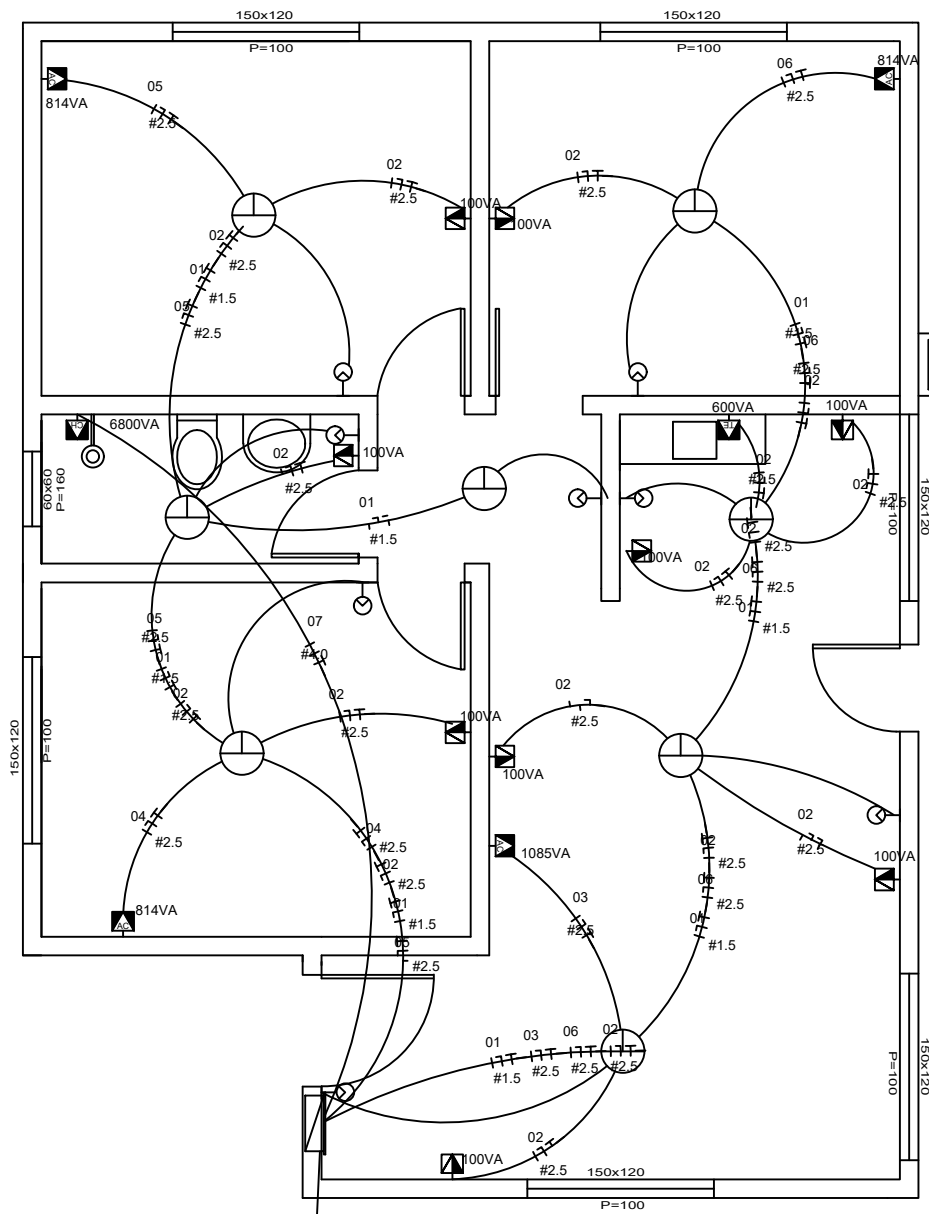

Circuito	Seção (mm²)	Disjunt (IN)(A)	Tensão (V)	Potência (W)	Descrição do Circuito
01	1,5	10	220 V	240	iluminação
02	2,5	16	220 V	1500	tomadas
03	2,5	10	220 V	1085	split 1
04	2,5	10	220 V	814	split 2
05	2,5	10	220 V	814	split 3
06	2,5	10	220 V	814	split 4
07	4	32	220 V	6800	chuveiro

Prefeitura Municipal de Ivorá

Planta Instalações elétricas – Unidades Habitacionais – 55,70 m²

Vitor Camargo Costa
CREARS 203284

Data: 03/2026



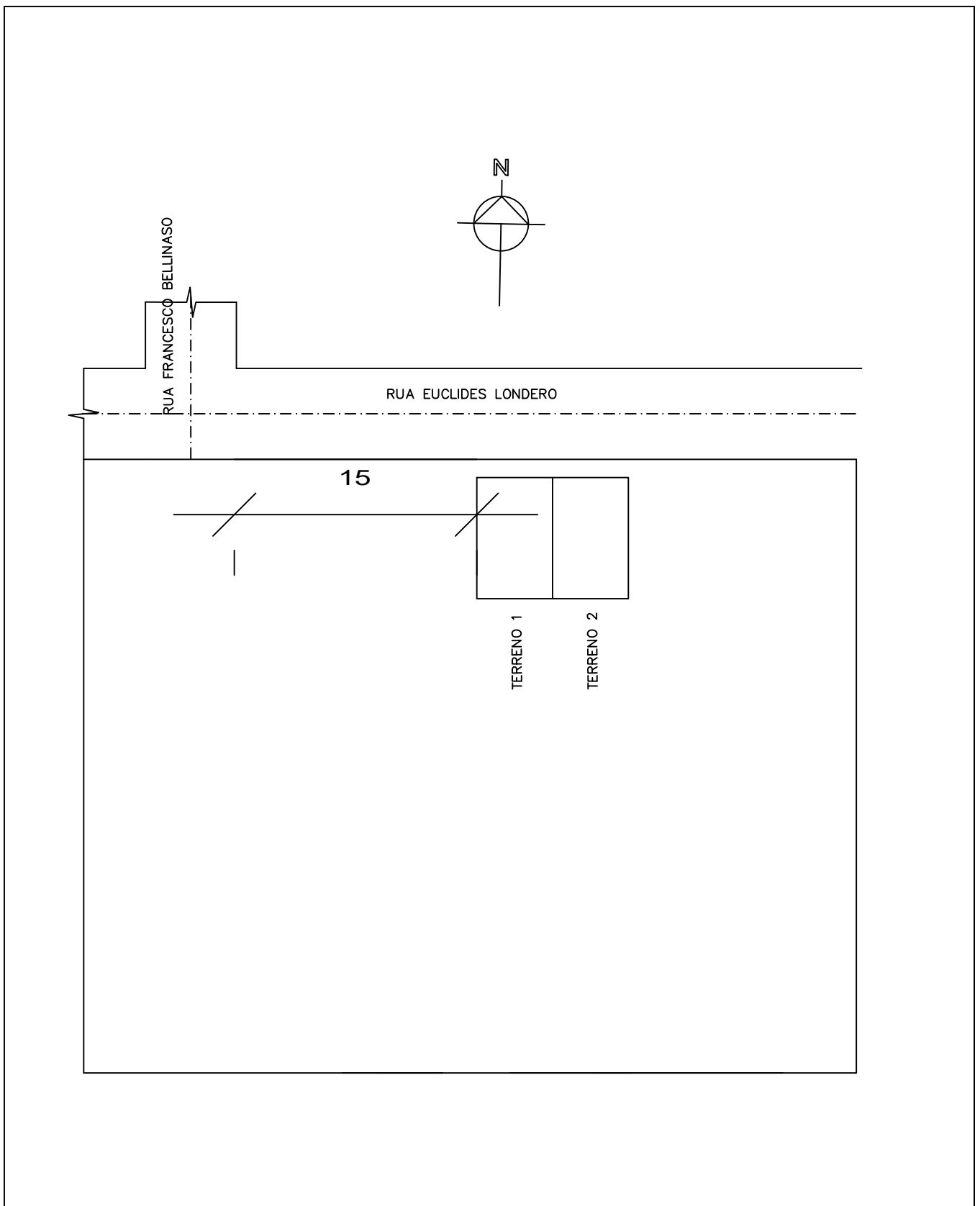

Prefeitura Municipal de Ivorá

Situação – Unidades Habitacionais – 55,70 m²

Vitor Camargo Costa
CREARS 203284

Data: 03/2026

